

ASSEMBLY INSTRUCTIONS:

Product Code : OASIS BL

Product Name: OASIS Mesh Chair

TIME REQUIRED:

15 minutes

TOOLS REQUIRED:

Screwdriver, Electric Drill, Pencil, Measuring tape/Ruler

*Tools are not included.

SKILL REQUIRED:

Easy  Hard

The Assembly Skill Rating is a 5-point system that shows the degree of effort needed in assembling a specific product. With 1 being easy for the average person and 5 requiring an expert. For most products, two persons are recommended.

NOTE

- As this is a commercial product, some intermediate skills may be required.
 - No pre-drill holes or markings are provided on our table or desk tops.
 - Please check you have all hardware before assembling.
- If you are missing any hardware, please contact your Rapidline reseller. Please ensure you have the name of the item, required hardware part and quantity.
 - Please retain your receipt as proof of purchase to validate your warranty.
- Assemble on a clean, flat, smooth surface such as a rug or carpet to avoid parts from being scratched.
 - Remove all wrapping materials, including staples and packing straps before you start to assemble
 - Keep all hardware parts out of reach of children.

CAUTION

- Heavy product. Do not attempt to lift or move without help
- Do not tighten screws and bolts until completely assembled.
- Do not use this product unless all bolts and screws are firmly secured and tightened.

WARNING

- If parts are missing, broken, damaged or worn stop using the product until all repairs are made.
 - Failure to follow these warnings could result in serious injury.

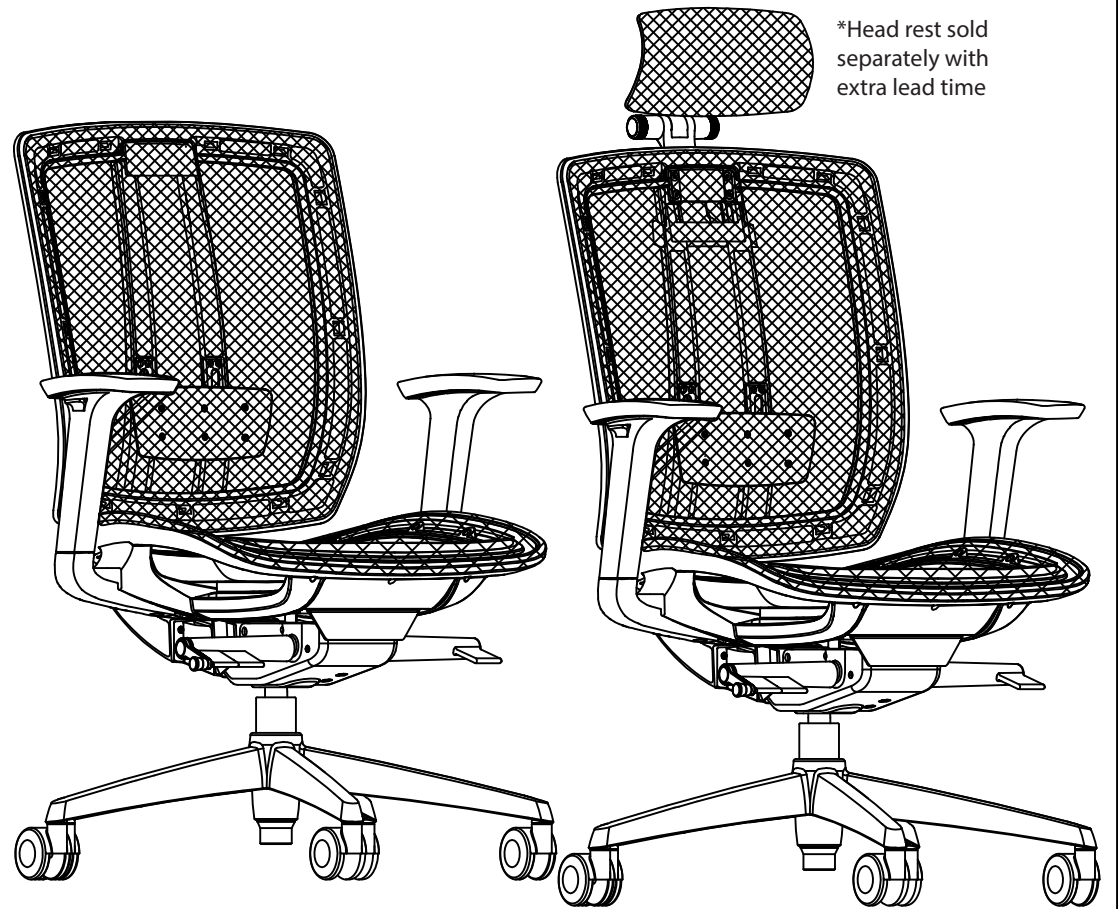
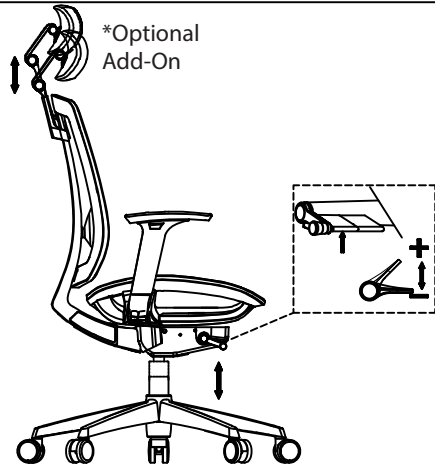
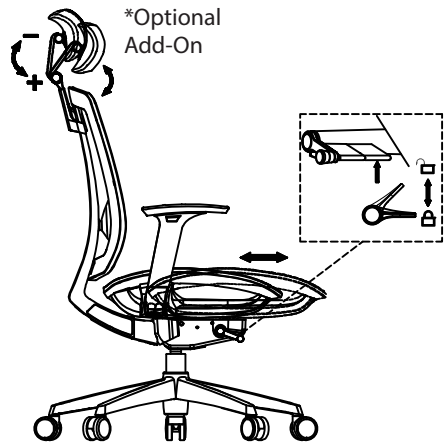
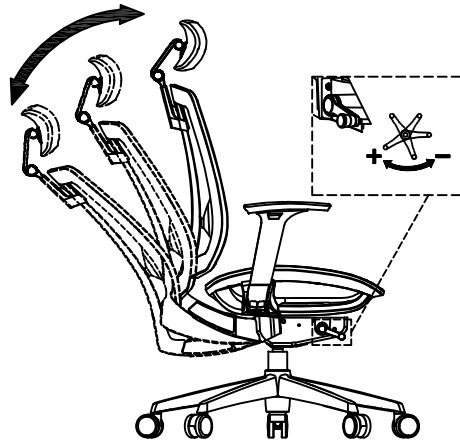
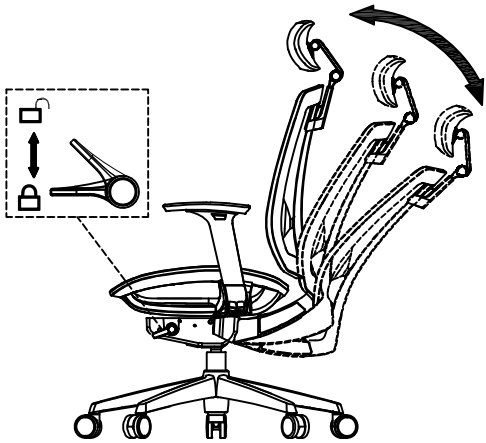
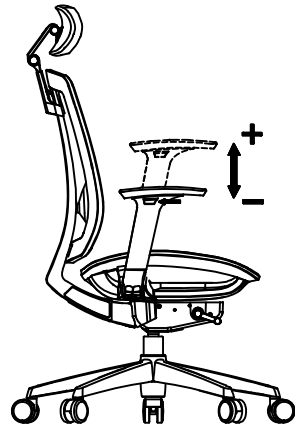
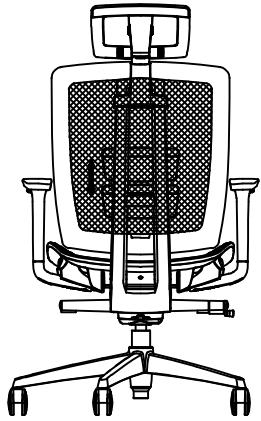

OASIS Chair operation manual

A  5PCS

J  1/4"*3/4 4PCS

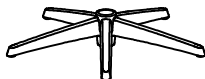
B  1PCS

K  1PCS

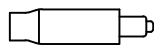
C  1PCS

O  1PCS

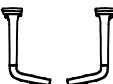
D  1PCS

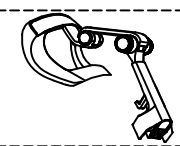
P  1PCS

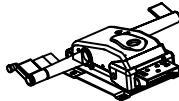
E  1PCS

Q  1/4*15MM 2PCS

F  1PCS

R  1PCS

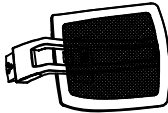
G  1PCS

PARTS P, Q, R ONLY IF ADD-ON HEADREST WAS PURCHASED

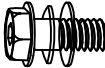
H  5/16"*3/4" 3PCS

rapidline
FURNITURE FOR TODAY

I  1/4"*1 6PCS

OASIS CHAIR ASSEMBLY INSTRUCTIONS

