

ASSEMBLY INSTRUCTIONS:

Product Code : CH12 / CH15 / CH18

Product Name: Rapid Span, Worker and Vibe Hutch

TIME REQUIRED:

30 minutes

TOOLS REQUIRED:

Screwdriver, Electric Drill, Pencil, Measuring tape/Ruler

*Tools are not included.

SKILL REQUIRED:

Easy ●●●●○ Hard

The Assembly Skill Rating is a 5-point system that shows the degree of effort needed in assembling a specific product. With 1 being easy for the average person and 5 requiring an expert. For most products, two persons are recommended.

NOTE

- As this is a commercial product, some intermediate skills may be required.
 - No pre-drill holes or markings are provided on our table or desk tops.
 - Please check you have all hardware before assembling.
- If you are missing any hardware, please contact your Rapidline reseller. Please ensure you have the name of the item, required hardware part and quantity.
 - Please retain your receipt as proof of purchase to validate your warranty.
- Assemble on a clean, flat, smooth surface such as a rug or carpet to avoid parts from being scratched.
 - Remove all wrapping materials, including staples and packing straps before you start to assemble
 - Keep all hardware parts out of reach of children.

CAUTION

- Heavy product. Do not attempt to lift or move without help
- Do not tighten screws and bolts until completely assembled.
- Do not use this product unless all bolts and screws are firmly secured and tightened.

WARNING

- If parts are missing, broken, damaged or worn stop using the product until all repairs are made.
 - Failure to follow these warnings could result in serious injury.

The logo for Rapidline, featuring the word "rapidline" in a lowercase, sans-serif font. The "i" in "rapid" has a small orange dot above it. The logo is set against a light blue rounded rectangular background.

ASSEMBLY INSTRUCTIONS







**OE 105WH/DG NV
BOOKCASE HUTCH**

DOC. NO. : RD-FB-KIT
REV. NO. : A
REV. DATE : 25.08.2008

Thanks you for purchasing this quality product. Be sure to lay all components on a soft and clean surface before assembly in order to avoid components from being scratched.

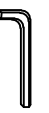
CAUTIONS :

1. Check contents against list for quantity.
2. Familiarize yourself with the components and hardware by reviewing the Assembly Instructions.
3. Do not over tightened the screws and bolts as it may damage the threads.
4. Keep all hardware parts out of the reach of children.

A		Hex Bolt And Caping 14 Pcs
B		Kix Cam 14 Pcs
C		Housing Cap (Short) 14 Pcs
D		Allen-Key 1 Pcs
E		Shelf Support Pin 18 Pcs
F		TZ Connector 4 Pcs
G		Screw M4 X 32mm 4 Pcs

STEP 1

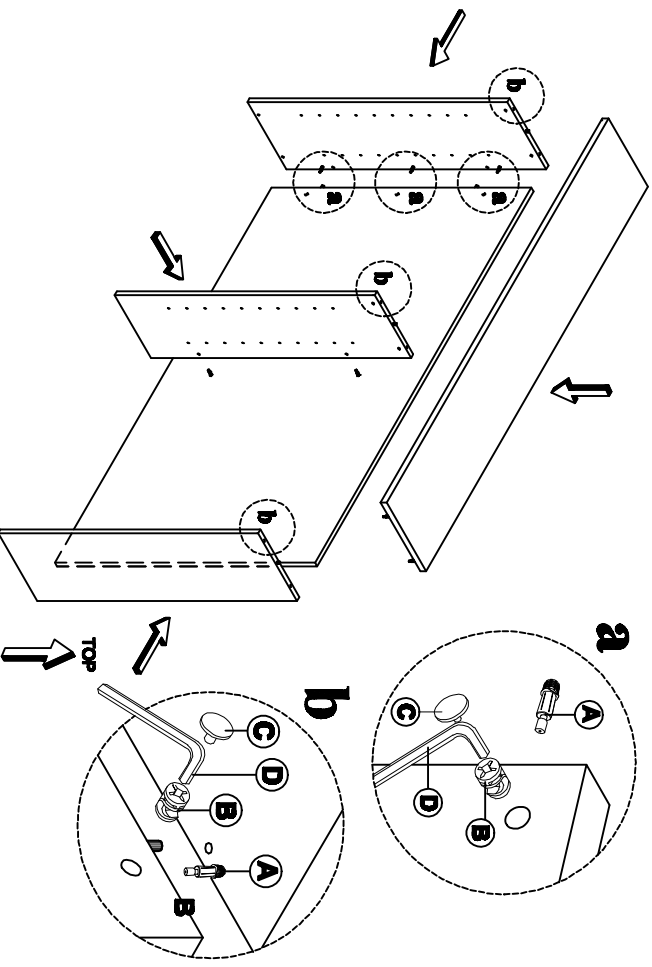

STEP 2

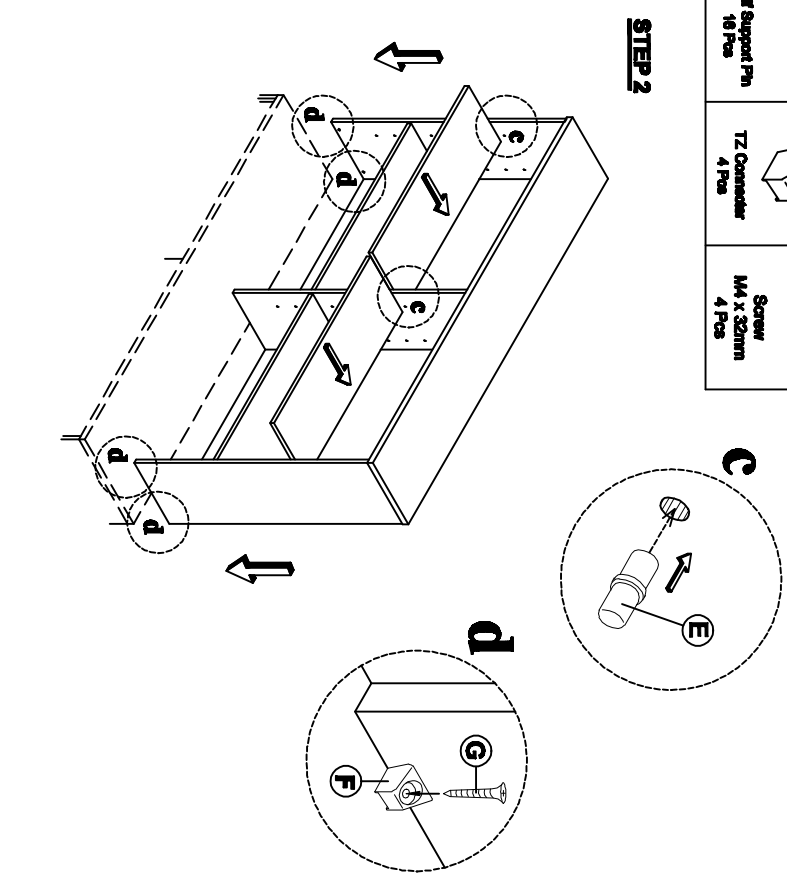

"Please make sure the bolt head is properly pulled / inserted into centre of housing zinc, ensuring that connections are positively secured and tight"