

Rapid Screen

Catalogue 2017

WORKSTATIONS - FURNITURE - SEATING - STORAGE - ACCESSORIES

WWW.RAPIDLINE.COM.AU

rapidline
FURNITURE FOR TODAY

RAPID SCREENS

SLIMLINE WORKSTATION SYSTEM

OFF THE SHELF, SLIMLINE WORKSTATION SYSTEM WITH MULTIPLE OPTIONS.



- Slimline Screen System
- Blue or Grey Screens
- White or Beech Tops
- 1250H or 1650H Screens
- Pinable Screens

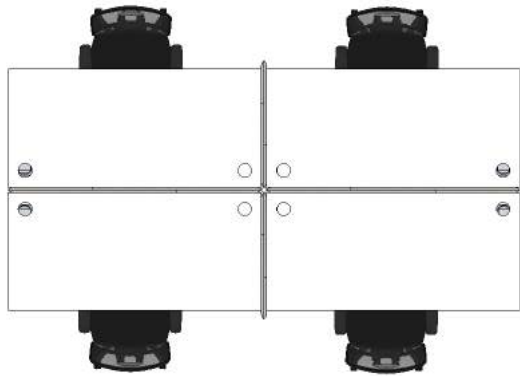

MAXIMISE SPACE WITH CUBICLES



SPREAD OUT WITH 3 WAY 120° WORKSTATION

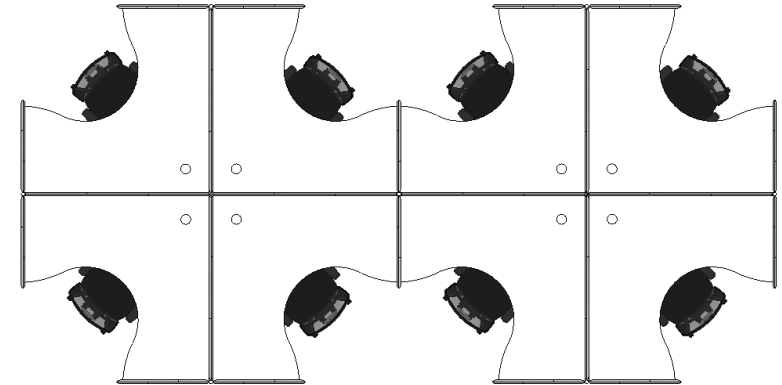

4 WAY WORKSTATION FOR MAXIMUM WORKSPACE

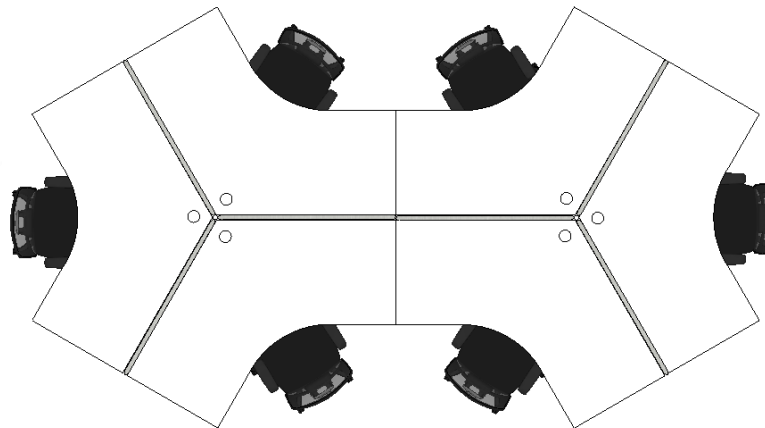

CREATE YOUR WORKSTATION ENVIRONMENT

- We can help from consultation and planning to providing drawings or 3D rendered images of your design.

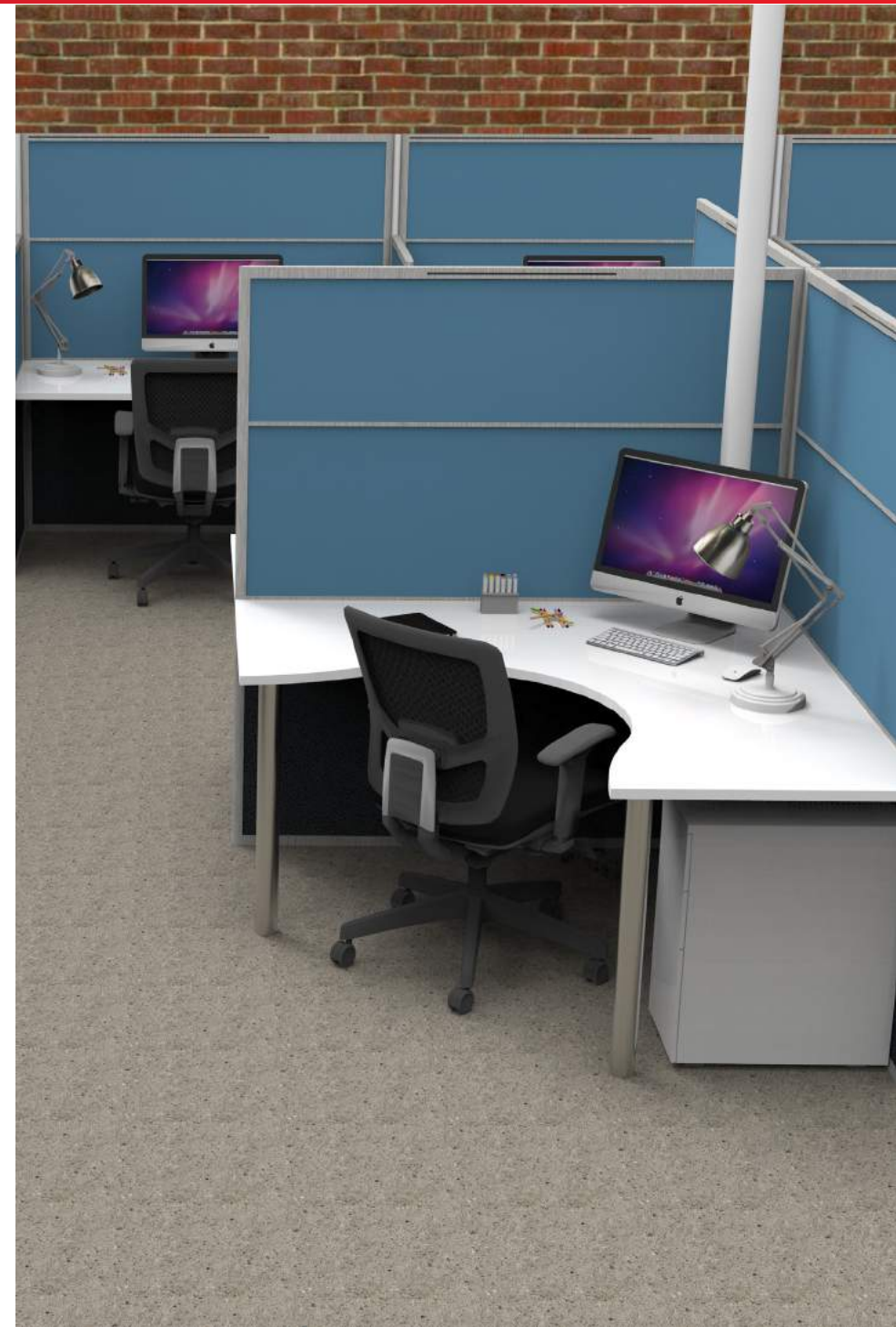

RAPID SCREEN

WORKSTATION TOP SIZES - Beech or White

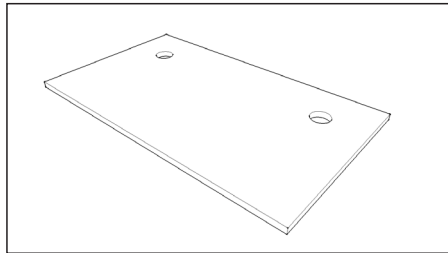

▪ 1200 X 700

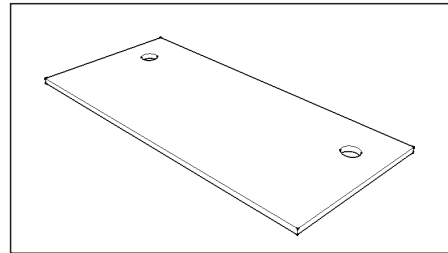

▪ 1500 X 700

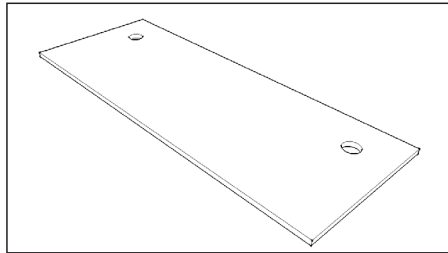

▪ 1800 X 700

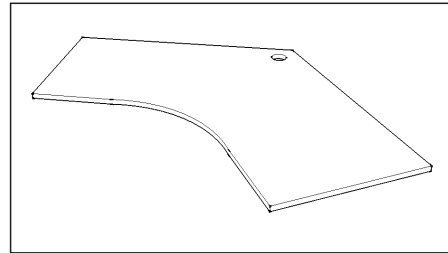

▪ 1200 X 1200 X 700

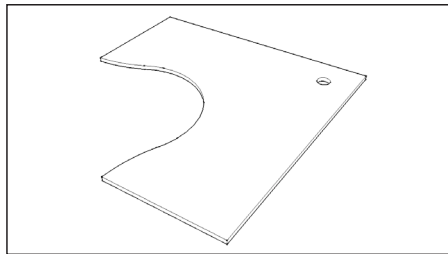

▪ 1500 X 1500 X 700

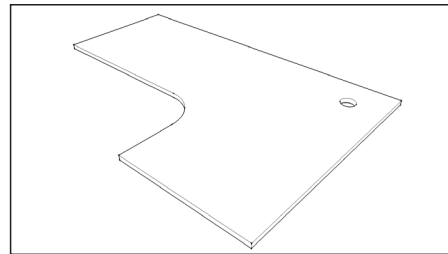

▪ 1800 X 1200 X 700

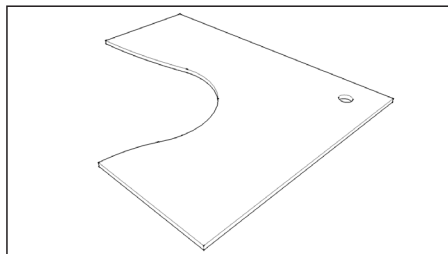

▪ 1800 X 1500 X 700

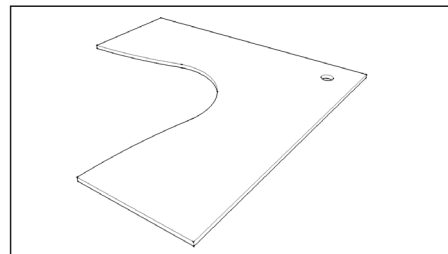

▪ 1800 X 1800 X 700

RAPID SCREEN SYSTEM - Grey or Blue



Joining Poles

- Link at 90 or 120 degrees



1250 High Screens

- Available in Widths: 750, 1200, 1500 & 1800

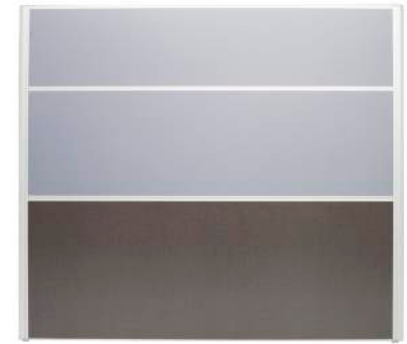

1650 High Screens

- Available in Widths: 750, 1200, 1500 & 1800

LEG SYSTEMS



SPAN LEG
▪ White



SPAN LEG
▪ Black



SPAN LEG
▪ Silver



ADJUSTABLE LEG
▪ White or Silver



CLEG
▪ Silver C Leg



DC60-CH
▪ Chrome Round Leg
60mm, Adjustable Foot

ACCESSORIES



900mm Shelf
▪ Shown with Brackets



4 Space Document
Divider



Document Tray

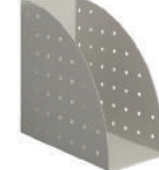

File Holder



Double Pen Holder



Triple Pen Holder



Free Standing Foot



Wall Starter